

ER14335 Lithium Thionyl Chloride Battery

Brief Datasheet

1 Basic Specification

(Typical values relative to cells stored for one year or less at +30°C max.)

Nominal capacity (at 1.3mA +23°C,2.0V cut off)	1650mAh
Nominal voltage	3.6V
Standard discharge current	1.3mA
Maximum continuous current	75mA
Maximum pulse current	150mA
Operating temperature range	-55°C- +85°C
Storage temperature (recommended)	+30°C Max
Weight	13g

*Energy type is bobbin structure and best suit for low current discharge. It may require depassivation before medium currents can be delivered.

*Underwriters Laboratories (UL) Component Recognition (File Number MH 20555).

2 Dimension

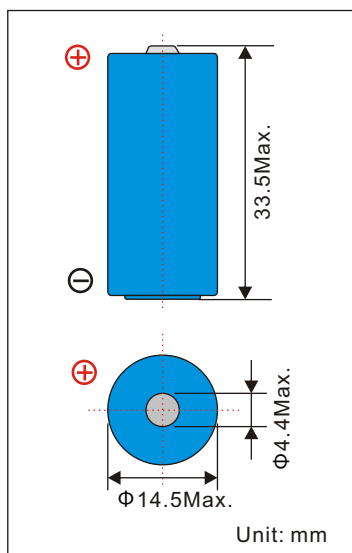

3 Electrical Characteristics

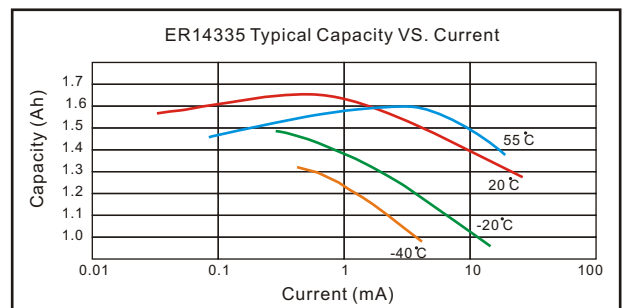
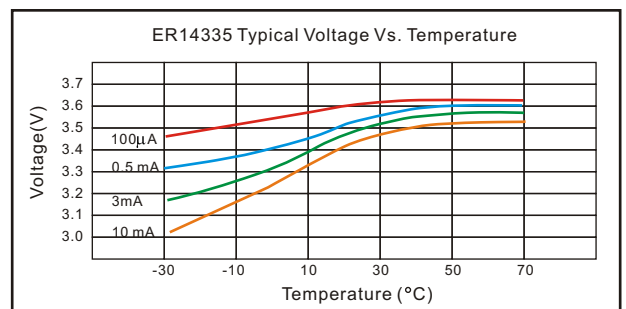
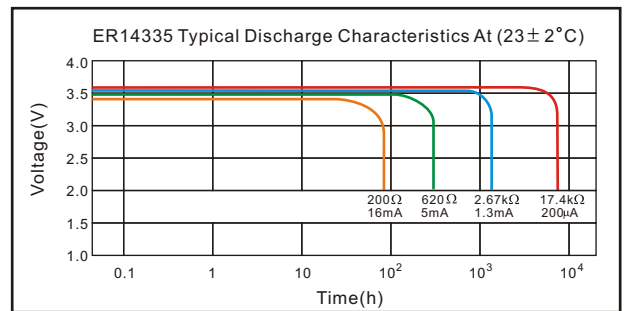

ENERGY TYPE

Note: Any representations in this brochure concerning performance, are for informational purposes only and are not construed as warranties either expressed or implied, of future performance.