

imax

B6AC

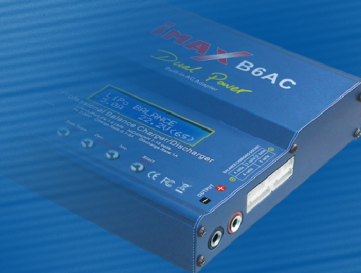

Instruction Manual

Professional Intelligent Digital Balance Charger

TABLE OF CONTENTS

INTRODUCTION.....	1
SPECIAL FEATURES.....	2
SPECIFICATIONS.....	5
LITHIUM POLYMERBALANCE CHARGE PROGRAM CONNECTION DIAGRAM.....	6
WARNING AND SAFETY NOTES.....	7
PROGRAM FLOW CHART	12
INITIAL PARAMETER SETUP (USERSSET UP).....	14
CHARGING OF LITHIUMBATTERY IN CHARGE MODE.....	18
CHARGING OF LITHIUMBATTERY IN BALANCE MODE.....	19
FAST CHARGING OF LITHIUM BATTERY.....	20
STORAGE CONTROL OF LITHIUM BATTERY.....	21
DISCHARGING OF LITHIUMBATTERY.....	22
CHARGING OF NICD/NIMHBATTERY.....	23
DISCHARGE OF NICD/NIMHBATTERY.....	24
CHARGE/DISCHARGE AND DISCHARGE/CHARGE CYCLE OF NICD/NIMH BATTERY.....	25
CHARGING OF THEPB BATTERY.....	26
DISCHARGING OF THEPB BATTERY.....	27
DATA STORAGE PROGRAM.....	28
LOAD DATA PROGRAM.....	29
VARIOUS INFORMATION IN THE PROGRAM.....	30
WARNING AND ERROR MESSAGE.....	31
WARRANTY ANDSERVICE.....	33

INTRODUCTION

Thank you for purchasing the B6AC LiPo Balance Charger by iMAX. This product is a rapid charger with a high performance microprocessor and specialized operating software. Please read this entire operating manual completely and attentively before using this product, as it covers a wide range of information on operating and safety. Or please do use this product in company with a specialist!



. Scroll through the Main Menu
. Stop any charge processes

Alter values
See the status of individual
cells in balance charge mode

. Resume or start charge processes
. Confirm an action

SPECIAL FEATURES

SPECIAL FEATURES

Optimized operating software

B6AC features the so-called AUTO function that set the feeding current during the process of charging or discharging. Especially for Lithium batteries, it can prevent the overcharging which may lead to an explosion due to the user's fault. It can disconnect the circuit automatically and alarm once detecting any malfunction. All the programs of this product were controlled through two way linkage and communication, to achieve the maximum safety and minimize the trouble. All the settings can be configured by users!

Internal independent lithium battery balancer

B6AC employs an individual-cell-voltage balancer. It isn't necessary to connect an external balancer for balance charging.

Balancing individual cells battery discharging

During the process of discharging, B6AC can monitor and balance each cell of the battery individually. Error message will be indicated and the process will be ended automatically if the voltage of any single one cell is abnormal.

Adaptable to various type of lithium battery

B6AC is adaptable to various types of Lithium batteries, such as Li-ion, LiPo and the new LiFe series of batteries.

Fast and storage mode of lithium battery

Purposes to charge Lithium battery varies, 'fast' charge reduce the duration of charging, whereas 'store' state can control the final voltage of your battery, so as to store for a long time and protect useful time of the battery.

Maximum safety

Delta-peak sensitivity: The automatic charge termination program based on the principle of the Delta-peak voltage detection. When the battery's voltage exceeds the threshold, the process will be terminated automatically.

Automatic charging current limit

You can set up the upper limit of the charging current when charging your NiCd or NiMH battery; it is useful for the NiMH battery of low impedance and capacity in the 'AUTO' charging mode.

Capacity limit

The charging capacity is always calculated as the charging current multiplied by time. If the charging capacity exceeds the limit, the process will be terminated automatically when you set the maximum value.

Temperature threshold*

The battery's internal chemical reaction will cause the temperature of the battery to rise. If the temperature limit is reached, the process will be terminated.

* This function is available by connecting optional temperature probe, which is not included in our package.

Processing time limit:

You can also limit the maximum process time to avoid any possible defect.

Input power monitoring

To protect the car battery used as DC input power from being damaged, its voltage keeps being monitored. If it drops below the lower limit, the process will be ended automatically.

Data store/load

The maximum five batteries' data can be stored for users' convenience. You can keep the data pertaining to program setting of the battery of continuous charging or discharging. Users can call out these data at anytime without any special program setting.

SPECIAL FEATURES

Cyclic charging/discharging

1 to 5 cyclic and continuous process of charge>discharge or discharge>charge is operable for battery refreshing and Balancing to stimulate the battery's activity.

Specifications:

Operating voltage range:	DC11.0~18.0 Volt AC in:100V~240V 50/60Hz
Circuit power:	Max. charge power50W Max. discharge power5W
Charge current range:	0.1~5.0A
Discharge current range:	0.1~1.0A
Current drain for balancing Li-po:	300mA/cell
NiCd/NiMH battery cell count:	1~15cell
li-ion/Polymer cell count:	1~6 series
Pb battery voltage:	2V~20V
Weight:	531g(Net Weight)
Dimensions:	134 X 142 X 36mm

LITHIUM POLYMER BALANCE CHARGE PROGRAM CONNECTION DIAGRAM

LITHIUM POLYMER BALANCE CHARGE PROGRAM CONNECTION DIAGRAM

This diagram shows the correct way to connect your battery to the B6AC charger while charging in the balance charge program mode only.

WARNING:

Failure to connect as shown in this diagram will damage this charger.







The main battery leads must be connected along with the balance lead connector as shown before charging your battery ..

WARNING:

❗ If using crocodile clips as shown in above diagram, please notice they are unable to touch together!

 *WARNING AND SAFETY NOTES*

These warnings and safety notes are particularly important. Please follow the instructions for maximum safety; otherwise the charger and the battery can be damaged or at worst it can cause a fire.

-  Never leave the charger unattended when it is connected to its power supply. If any malfunction is found, TERMINATE THE PROCESS AT ONCE and refer to the operation manual.**
-  Keep the charger well away from dust, damp, rain, heat, direct sunshine and vibration. Never drop it.**
-  The allowable input voltage is 11-18V DC/110-240V AC**
-  This charger and the battery should be put on a heat-resistant, nonflammable and nonconductive surface. Never place them on a car seat, carpet or similar. Keep all the inflammable volatile materials away from operating area.**
-  Make sure you know the specifications of the battery to be charged or discharged to ensure it meets the requirements of this charger. If the program is set up incorrectly, the battery and charger may be damaged. It can cause fire or explosion due to overcharging. This warranty is not valid for any damage or subsequent damage arising as a result of a misuse or failure to observe the procedures outlined in this manual.**

WARNING AND SAFETY NOTES

NiCd/NiMH

Voltage level: 1.2V/cell

Allowable fast charge current: 1C-2C (depends on the performance of cell)

Discharge voltage cut off level: 0.85V/cell (NiCd), 1.0V/cell (NiMH)

Li-ion Voltage level: 3.6V/cell

Max. charge voltage: 4.1V/cell

Allowable fast charge current: 1C or less

Min. discharge voltage cut off level: 2.5V/cell or higher

LiPo Voltage level: 3.7V/cell

Max. charge voltage: 4.2V/cell

Allowable fast charge current: 1C or less

Discharge voltage cut off level: 3.0V/cell or higher

LiFe Voltage level: 3.3V/cell

Max. charge voltage: 3.6V/cell

Allowable fast charge current: 4C or less

Discharge voltage cut off level: 2.0V/cell or higher

Pb Voltage level: 2.0V/cell

(Lead-acid) Max. charge voltage: 2.46V/cell

Allowable fast charge current: 0.4C or less

Discharge voltage cut off level: 1.75V/cell or higher

WARNING AND SAFETY NOTES

- !** To avoid short circuit between the charge lead always connect the charge cable to the charger first, then connect the battery. Reverse the sequence when disconnecting.
- !** Do not connect more than one battery pack to this charger at any one time.
- !** Never attempt to charge or discharge the following types of batteries.

A battery pack which consists of different types of cells (including different manufacturers)

A battery that is already fully charged or just slightly discharged.

Non-rechargeable batteries (Explosion hazard).

Batteries that require a different charge technique from NiCd, NiMh, LiPo or Gel cell (Pb, Lead acid).

A faulty or damaged battery.

A battery fitted with an integral charge circuit or a protection circuit.

Batteries installed in a device or which are electrically linked to other components.

Batteries that are not expressly stated by the manufacturer to be suitable for the currents the charger carries during the charge process.

WARNING AND SAFETY NOTES

! Please bear in mind the following points before commencing charging:

Did you select the appropriate program suitable for the type of battery you are charging?

Did you setup adequate current for charging or discharging?

Have you checked the battery voltage? Lithium battery packs can be wired in parallel and in series, i.e. a 2 cell pack can be 3.7V (in parallel) or 7.4V (in series).

Have you checked that all connections are firm and secure? Make sure there are no intermittent contacts at any point in the circuit.

! Charging

During charge process, a specific quantity of electrical energy is fed into the battery. The charge quantity is calculated by multiplying charge current by charge time. The maximum permissible charge current varies depending on the battery type or its performance, and can be found in the information by the battery manufacturer. Only batteries that are expressly stated to be capable of quick-charge are allowed to be charged at rates higher than the standard charge current.

Connect the battery to the terminal of the charger: red is positive and black is negative. Due to the difference between resistance of cable and connector, the charger can not detect resistance of the battery pack, the essential requirement for the charger to work properly is that the charge lead should be of adequate conductor cross-section, and high quality connectors which are normally gold-plated should be fitted to both ends

Always refer to the manual by the battery manufacturer pertaining to charging methods, recommended charging current and charging time. Especially, the Lithium battery should be charged according the charging instruction provided by the manufacturer strictly.

Attention should be paid to the connection of Lithium battery especially.

Do not attempt to disassemble the battery pack arbitrarily

Please get highlighted that Lithium battery packs can be wired in parallel and in series. In the parallel connection, the battery's capacity is calculated by multiplying single battery's capacity by the number of cells with total voltage stay the same. The voltage's imbalance may cause fire or explosion. Lithium battery is recommended to charge in series.

Discharging

The main purpose of discharging is to clean residual capacity of the battery, or to reduce the battery' voltage to a defined level. The same attention should be paid to the discharging process as charging. The final discharge voltage should be set up correctly to avoid deep-discharging. Lithium battery can not be discharged to lower than the minimum voltage, or it will cause a rapid loss of capacity or a total failure. Generally, Lithium battery doesn't need to be discharged. Please pay attention to the minimum voltage of Lithium battery to protect the battery.

Some rechargeable batteries have a memory effect. If they are partly used and recharged before the whole charge is accomplished, they remember this and will only use that part of their capacity next time. This is a 'memory effect' It is said that NiCd and NiMH batteries are suffering from memory effect. NiCd has more memory effect than NiMH.

Lithium batteries are recommended to be discharged partially rather than fully discharged. Frequent full discharging should be avoided if possible. Instead, charge the battery more often or use a battery of larger capacity. Full capacity cannot be used until it has been subjected to 10 or more charge cycles. The cyclic process of charge and discharge will optimize the capacity of battery pack.

PROGRAM FLOW CHART

Program flow chart

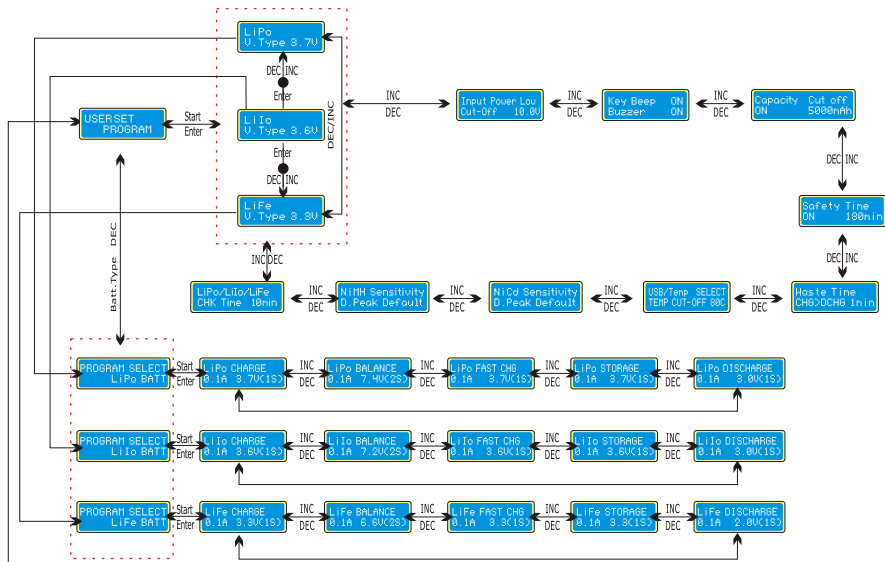

Continue on next page!

Program flow chart

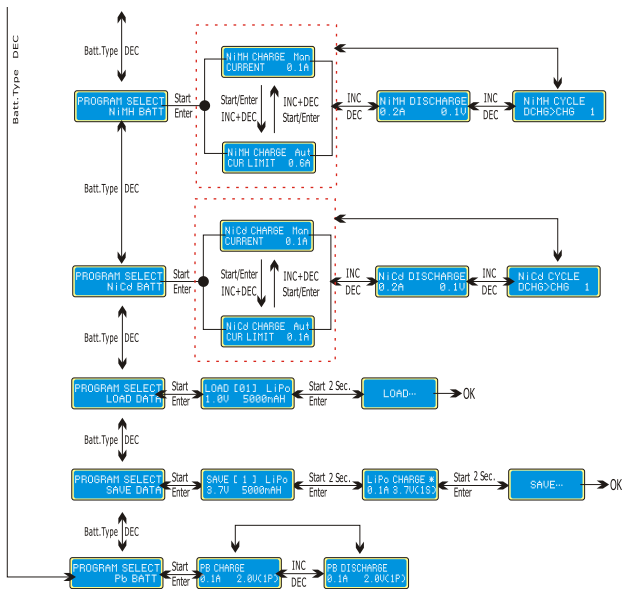

INITIAL PARAMETER SETUP (USERSSET UP)

As default this charger will be set to typical user settings when it is connected to AC 110-240V or DC 11-18V for the first time. The screen displays the following information in sequence and the user can change the parameter on each screen.

If you need to alter the parameter value in the program, press “Start/Enter” key to make it blink then change the value with “INC” or “DEC” key. The value will be stored by pressing “Start/Enter” key once.

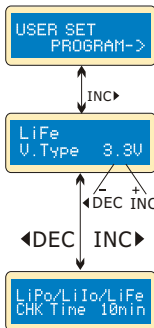

User setup starting screen.

The screen displays the nominal voltage of Lithium battery. There are three kinds of Lithium battery: LiFe(3.3V), Lilo(3.6V) or LiPo(3.7V). This is very important so you have to check the battery carefully and set it up correctly. If it is different from correct value the battery may be exploded during charge process.

B6AC recognize the cell count of Lithium battery automatically at the beginning of charge or discharge process to avoid from erroneous setting by user. But deeply discharged battery can be perceived incorrectly. To prevent the error, you can set the time term to verify the cell count by the processor. Normally, 10 minutes are enough to perceive the cell count correctly. For the battery of larger capacity, you may extend the time term. But if you set the time term to long for the battery of smaller capacity, the charge or discharge process can be finished within the time term with the erroneous cell count. This may cause the fatal result. If the processor recognizes the cell count incorrectly at the beginning of charge or discharge process, you may extend the time. Otherwise, you had better use with the default value.

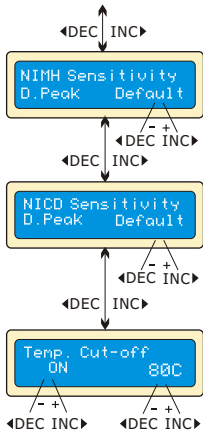

This shows the trigger voltage for automatic charge termination of NiMH and NiCd battery. The effective value ranges from 5 to 20mV per cell. If the trigger voltage is set higher, there is a danger of overcharging the battery; if it is set lower, there is a possibility of premature termination. Please refer the technical specification of the battery. (NiCd default: 12mV, NiMH default: 7mV)

An optional feature using temperature probe contacting the surface of battery, the temperature cut-off can be on or off. If it is on, set the maximum temperature at which the charger should allow battery to reach during charge. Once a battery reaches this temperature during charge, the process will be terminated to protect the battery.

INITIAL PARAMETER SETUP (USERSSET UP)

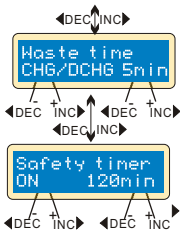

The battery becomes warm after cycles of charge/discharge process. The program will insert a time delay after each charge/discharge process to allow the battery enough time to cool down before beginning next cycle of charge/discharge process. The valid value ranges from 0 to 60 minutes.

When the charge process starts, the integrated safety timer starts to run simultaneously. If error detected or the termination circuit can not detect whether the battery is fully charged or not, this unit is programmed to prevent overcharging. Please refer to the below statement to calculate the timer you set.

Safe timer Calculation

When charging NiCd or NiMH batteries, divide the capacity by current, then divide the result by 11.9, set this number of minutes as the value for safety timer setting. If the charger stopped at this time threshold, about 140% of the capacity will have been fed into the battery.

For example:

Capacity	Current	Safety Time
2000mAh	2.0A	$(2000/2.0=1000)/11.9=84$ minutes
3300mAh	3.0A	$(3300/3.0=1100)/11.9=92$ minutes
1000mAh	1.2A	$(1000/1.2=833)/11.9=70$ minutes

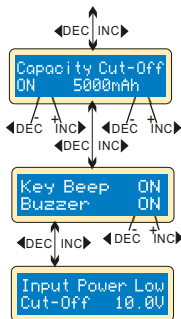

The program provides maximum capacity protection function. If the Delta-peak voltage can not be detected or the safety timer times out, the charge process will stop automatically, when the battery reaches the user-set maximum charge capacity,

The beep to confirm users' operation sounds every time a button is pressed. The beep or melody sounds at various times during operation to confirm different mode change. These functions can be switched on or off.

This function monitors the voltage of the input battery used to power this charger. If the voltage is lower than user-set value, the program will end forcibly to protect the input battery.

Lithium (LiPo/LiIo/LiFe) program

The program is only suitable for charging/discharging Lithium(LiPo/LiIo/LiFe) batteries with a nominal voltage of 3.3/3.6/3.7V/cell. Different batteries have different charge technique. There are two methods termed as constant voltage and constant current. The charge current varies according to battery capacity and specification. The final voltage is very important; it should precisely match the voltage of the battery: LiPo is 4.2V, LiIo is 4.1V and LiFe is 3.6V. The current and voltage of the battery should be correctly set.

When you want to change the values of parameters, please press START/ENTER key to make it blink and then use DEC or INC to change the value. Then press START/ENTER key again to store the value.

CHARGING OF LITHIUM BATTERY IN CHARGE MODE

Charging of Lithium battery

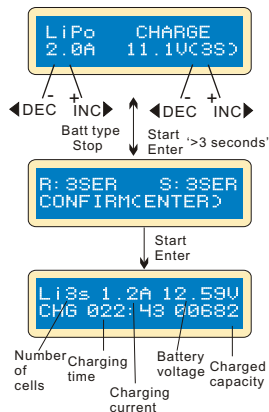

The left side of the first line shows the type of battery you choose. The value on the left of the second line of the charger is current user set, After setting the current and voltage, press START/ENTER key for more than 3 seconds to start the process.(charge current: 0.1-5.0A, voltage: 3.7-22.2V).

This displays the number of cells you set up and the processor detects. "R" shows the number of cells detected by the charger and "S" is the number of cells set by you at the previous screen. If both numbers are identical you can start charging by press START/ENTER button. If not, press BATT TYPE/STOP button to go back to previous screen to carefully check the number of cells of the battery pack before going ahead.

This screen shows the real-time status during charge process. Press BATTTYPE/STOP key once to stop the charge process.

Charging lithium battery in the charge mode

This charging mode is for charging Li-Po/Ion/Fe battery without balance lead.

CHARGING OF LITHIUM BATTERY IN BALANCE MODE

Balance Charging of Lithium battery

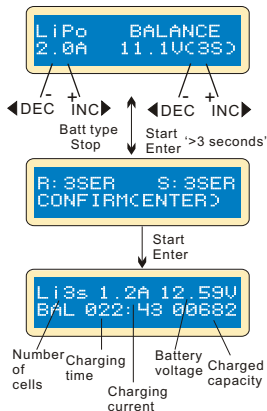

The left side of the first line shows the type of battery you choose. The value on the left of the second line of the charger is current user set, After setting the current and voltage, press START/ENTER key for more than 3 seconds to start the process.(charge current: 0.1-5.0A, voltage: 3.7-22.2V).

This displays the number of cells you set up and the processor detects. "R" shows the number of cells detected by the charger and "S" is the number of cells set by you at the previous screen. If both numbers are identical you can start charging by press START/ENTER button. If not, press BATT TYPE/STOP button to go back to previous screen to carefully check the number of cells of the battery pack before going ahead.

This screen shows the real-time status during charge process. Press BATTTYPE/STOP key once to stop the charge process.

Charging lithium battery in the balance mode

This function is for balancing the voltage of Lithium-polymer battery cells while charging. In the balance mode, the battery needs to have a balance lead to connect to the individual balance port at the right side of the charger. And you need to connect the battery's power lead to the output of charger.

Charging in this mode is different from the normal modes, because the built-in processor monitors voltage of individual cell and control input current fed into each cell to equalized voltage of individual cell.

FAST CHARGING OF LITHIUM BATTERY

Fast charging of Lithium battery

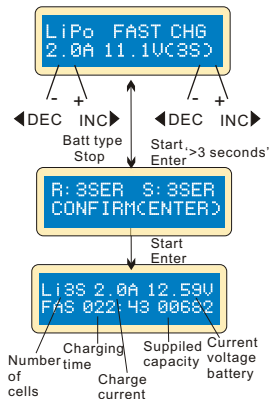

The value on the left side of the second lines sets the charge current. The value on the right side of the second lines sets the battery pack's voltage. After setting current and voltage, press STAR/ENTER for more than 3 seconds to start the process.

This displays the number of cells you set up and the processor detects. "R" shows the number of cells detected by the charger and "S" is the number of cells set by you at the previous screen. If both numbers are identical you can start charging by press START/ENTER button. If not, press BATTTYPE/STOP button to go back to previous screen to carefully check the number of cells of the battery pack before going ahead.

This screen shows the real-time status during charge process. Press BATTTYPE/STOP key once to stop the charge process.

Charging lithium battery in the fast charge mode

Charging current will become lower when it progress to the end of charging. A specific CV process will be reduced to end the charging process earlier. In fact, the charging current will goes to 1/5 when the charging process comes to 1/10. Charging capacity will be little smaller than normal charging, but charging time will be shortened accordingly.

Storage control of Lithium battery

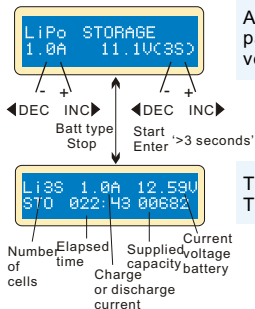

At this screen, you can set up the current and voltage of the battery pack. Charging and discharging will make the batteries come to the voltage level of “storage” state.

This screen shows the real-time status charging. Press BATT TYPE/STOP key once to stop the charge process.

Charging lithium battery in the storage mode

This function is for charging/discharging batteries which are not used at once. This program is designed for charging or discharging of batteries of specific original state. They are classified by types: 3.75V Lilo, 3.85V LiPo and 3.3V LiFe. The program will begin to discharge if the original state of the battery exceeds the voltage level of storage.

DISCHARGING OF LITHIUM BATTERY

Discharging of Lithium battery

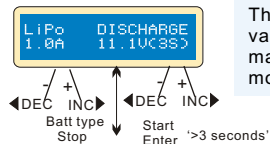

The value of discharge current on the left can not exceed 1C, and the value on the right can not be under the voltage recommended by the manufacturer to avoid deep discharging. Press START/ENTER for more than 3 seconds to start discharging.

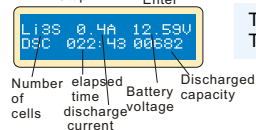

This shows the real-time status of discharging, you can press BATT TYPE/STOP key to stop discharging.

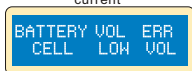

The processor detects voltage of one cell is too low.

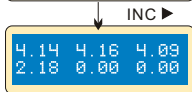

The 4th cell was damaged. The value of voltage may be zero if disconnection occurs.

Voltage balancing and monitoring in the discharge process

The processor monitors voltage of each cell when the battery packs are during its "storage" and "discharging" process. If voltage of any cell is abnormal, B6AC will show error message and terminate the program forcibly. So if there is battery damage or disconnection, you can see the error message and press INC to know which cell is damaged.

Charging of NiCd/NiMH battery

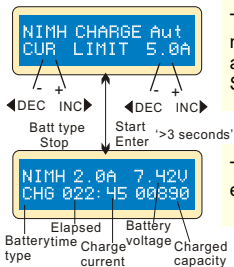

This program is for charging of NiCd/NiMH batteries associated with R/C models applications. You can press START/ENTER key to make it blink and then INC or DEC to change the parameter value. Press START/ENTER key to store the value.

The screen shows the real-time status. Press BATTTYPE/STOP key to end the program. The sound will be emitted to indicate the end of program.

Charging NiCd/NiMH battery in the charge mode

This program charges the battery using the current you set up. In the "auto" state, you should set up the upper limit of the charge current to avoid damage by excessive feeding current. Some batteries of low resistance and capacity can lead to higher current in the "auto" charging mode. But in the manual mode, it will charge with the current you set. You can make it blink in the current field and press INC and DEC simultaneously to swap between Auto and Manual Mode. NOTE: Allowable fast charge current: 1C-2C

DISCHARGE OF NiCd/NiMH BATTERY

Discharge of NiCd/NiMH battery

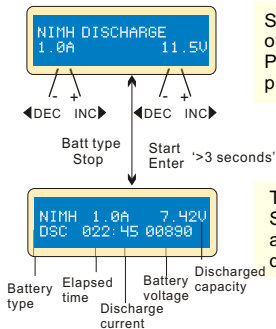

Set charge current on the left and the final voltage on the right. Range of the charge current is 0.1-1.0A; range of final voltage is 0.1-25.0V. Press START/ENTER key for more than 3 seconds to start the program.

The screen indicates the discharging state. You can press START/ENTER key to alter discharge current. Press START/ENTER again to store the value. Press BATT TYPE/STOP key to stop discharging. The emitted sound alerts the end of discharging.

CHARGE/DISCHARGE AND DISCHARGE/CHARGE CYCLE OF NiCd/NiMH BATTERY

Charge/discharge and discharge/charge cycle of NiCd/NiMH battery

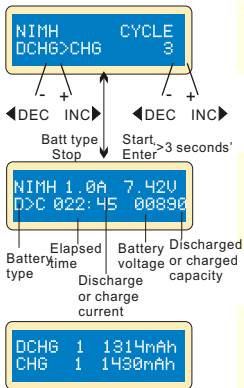

You can set up sequence on the left and the number of cycles on the right. Range of the cycle number is 1-5.

Press BATT TYPE/STOP key to stop program, you can press START/ENTER key to alter charge current. The sound indicates the end of program.

When it approaches to the end, you can see the capacity of the battery being charged or discharged. You can press INC or DEC key to display result of each cycle.

CHARGING OF THE PB BATTERY

Charging of the Pb battery



Pb CHARGE
4.0A 12.00V(6P)

◀DEC INC▶ ▶DEC INC▶
Batt type Start
Stop Enter '>3 seconds'

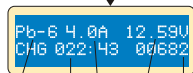

Pb-6 4.0A 12.59V
CHG 022:43 00682

Battery type Elapsed time Battery voltage Charged capacity
Charge current

Set up the charge current on the left and nominal voltage on the right. Range of current is 0.1-5.0A, the voltage should match the battery being charged. Press START/ENTER key for more than 3 seconds to start charging.

The screen displays the real-time discharging status. Press START/ENTER key to alter discharge current. Press START/ENTER key again to store the parameter value you set. Press BATT TYPE/STOP key to end the program.

Charging Pb (lead-acid) battery in the charge mode

This program is only suitable for charging Pb (lead-acid) battery with nominal voltage from 2 to 20V. Pb (lead-acid) battery is completely different from NiCd/NiMH battery. These batteries can only deliver current lower in comparison to their capacity. The same restriction applies to the charging process. Consequently, the optimum charge current can only be 1/10 of the capacity. Pb battery can not be used for fast-charging, please follow the instructions provided by the battery manufacturer.

Due to the chemistry characteristic of Pb battery, the cut off point may be difficult to detect sometimes. We recommend user to use CAPACITY CUT OFF feature to protect the battery. You can press START/ENTER key to make it blink and alter the value of parameters using INC or DEC key, press START/ENTER key to store the value.

Discharging of the Pb battery



Pb DISCHARGE
1.0A 12.0VC6P)

◀DEC INC▶ ▶DEC INC▶
Batt type Start
Stop Enter '>3 seconds'

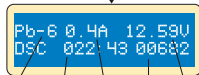

Pb-6 0.4A 12.59V
DSC 022:43 00682

Battery type Elapsed time Discharge current Battery voltage Discharged capacity

Set up the charge current on the left and nominal voltage on the right. Range of discharge current is 0.1-1.0A, the voltage should match the battery being charged. Press START/ENTER key for more than 3 seconds to start charging.

The screen displays the real-time discharging status. Press START/ENTER key to alter discharge current. Press START/ENTER key again to store the parameter value you set. Press BATTTYPE/STOP key to end the program.

DATA STORAGE PROGRAM

Data storage program

For your convenience, B6AC has a data storage and load program. It can store five battery data representing the respective specifications of batteries. You can call back the data when charging or discharging without setting up the program again. Press START/ENTER key to make it blink, and use INC or DEC to set up the parameter.

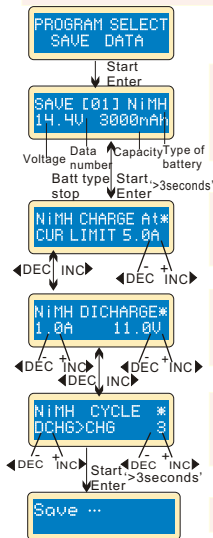

Setting of the parameter in the screen will not affect the charge and discharge process. They just present the specification of the battery. The example is NiMH battery pack, including 12 cells, the capacity is 3000m Ah.

Set up the charge current in the manual mode, or current limit in the auto mode. Press INC and DEC key simultaneously to make the current field blink to switch the charge mode.

Set up the discharge current and final voltage.

Set up the charge/ discharge sequence and cycle number.

Saving the data

Load data program

This program is to load the data stored at the “save data” program. Press START/ENTER key to make the data field blink and press INC or DEC for more than 3 seconds to load the data.

```
PROGRAM SELECT
LOAD DATA
```

Start
Enter

```
LOAD [01] NiMH
14.4V 3000mAh
```

Start '>3seconds'
Enter

```
Load ...
```

Choose the data number you want to call back. The data you want to call back will be displayed.

Loading the data.

VARIOUS INFORMATION IN THE PROGRAM

Various information in the program

You can inquire various information on the LCD screen during the charging and discharging process. Press DEC key, the charger will display users' setting. You can press INC key to monitor voltage of each cell while the battery is connected with each port of the charger.

End Voltag
12.6v(3s)

◀DEC

Capacity Cut-Off
On 5000mAh

◀DEC

Safety Tiner
ON 200min

◀DEC

Temp Cut-OFF
ON 80C 176F

◀DEC

Ext.Temp 26C

◀DEC

4.14 4.16 4.09
0.00 0.00 0.00

It comes to the final voltage when the program ended.

Displayed capacity cut-off function is turned on and the setting value of capacity.

Displayed safety timer is turned on and duration of time in minutes.

Displayed temperature cut-off function is turned on.

The external temperature is displayed when the temperature probe is used.

The battery is connected with each port through cable; you can check voltage of each cell in the battery pack. When the cable is connected with the ports on the charger, the program will display voltage of up to 6 batteries.

Warning and error message

B6AC incorporates a variety of functions for the systems to verify processes and the state of the electronics. In case of an error the screen will display the cause of error and emit an audible sound.

REVERSE POLARITY

Incorrect polarity connected.

CONNECTION BREAK

Battery connection is interrupted.

SHORT ERR

Short-circuit of the output termination.

INPUT VOL ERR

Input voltage incorrect.

VOL SELECT ERR

The voltage of the battery pack has been selected incorrectly!

BREAK DOWN

The charger has malfunctioned for some reason. Seek professional advice.

**BATTERY CHECK
LOW VOLTAGE**

The voltage is lower than which is set. Please check the number of cells in the battery pack.

WARNING AND ERROR MESSAGE

BATTERY CHECK
HIGH VOLTAGE

The voltage is higher than which is set. Please check the number of cells in the battery pack.

BATTERY VOLTAGE
CELL LOW VOL

Voltage of one cell in the battery pack is too low, please check the voltage of each cell.

BATTERY VOLTAGE
CELL HIGH VOL

Voltage of one cell in the battery pack is too high; please check the voltage of each cell.

BATTERY VOL ERR
CELL CONNECT

Wrong connection of the connector detected; please check the connector and cable.

TEMP OVER ERR

The internal temperature is too high, please cool down.

CONTROL FAILURE

The processor cannot control the feeding current, please repair it.

 ***Warranty and service***

We guarantee this product to be free of manufacturing and assembly defects for a period of one year from the time of purchase. The warranty only applies to material or operational defects, which are present at the time of purchase. During that period, we will repair or replace free of service charge for products deemed defective due to those causes.

You will be required to produce proof of purchase (invoice or receipt). This warranty is not valid for any damage or subsequent damage arising as a result of misuse, modification or as a result of failure to observe the procedures outlined in this manual.

iMAX
B6AC